



# Jf<sup>®</sup> Handrail

Jf<sup>®</sup> Handrail



wall-handrails  
with JF personality



**¿A QUÉ ESTÁS ESPERANDO?  
WHAT ARE YOU WAITING FOR?  
QU'EST-CE QUE TU ATTENDS?**

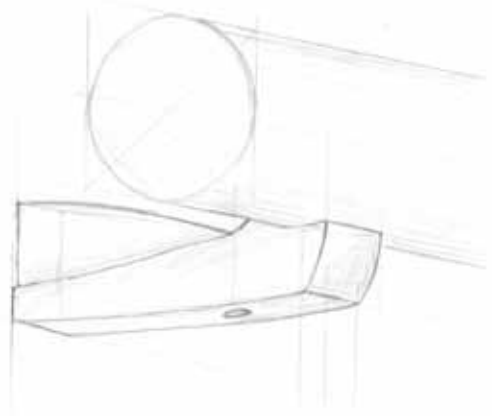
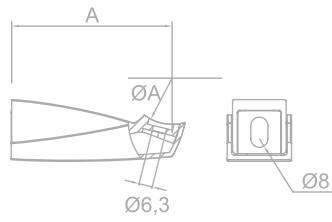

ST 317 BA AISI-316

New!

pcs/box	ØA	A
2	43	75
2	50,8	75

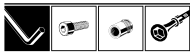

BA SATIN



Instalación / Installation / Installation



[img.1]



[img.2]



[img.3]



[img.4]



BA SATIN

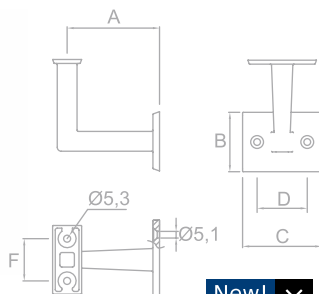
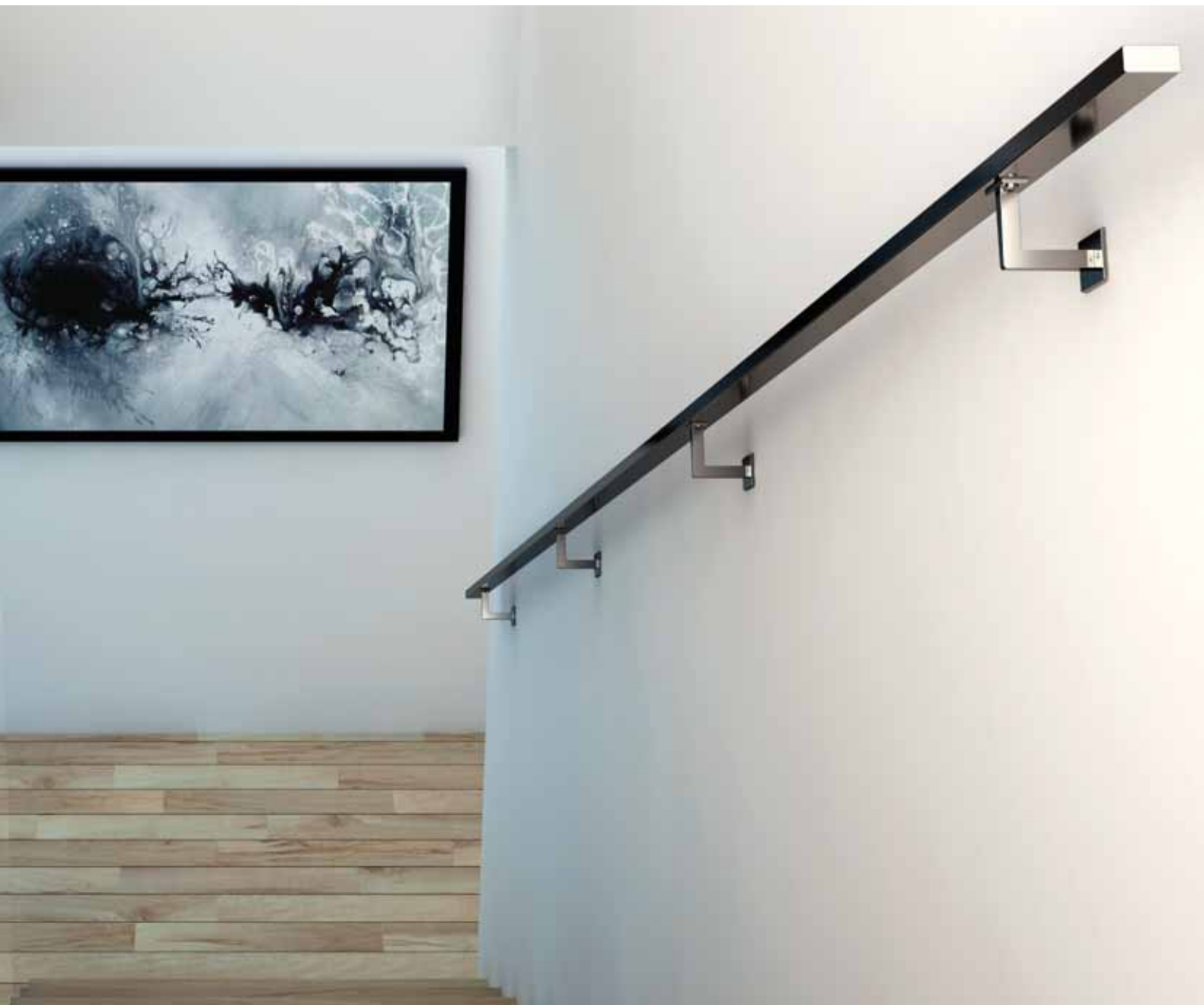

ST 335 BA AISI-316

New!

pcs/box	A	B	C	D	F
2	70	60	45	38	32



BA SATIN

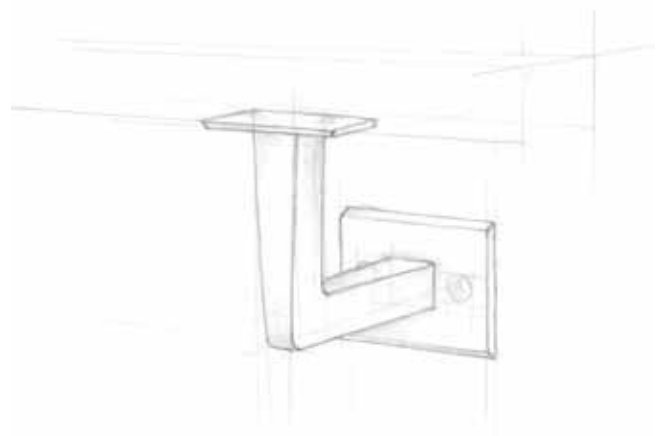

BA Acabado brillo / Polished finished / Finition poli

SATIN Acabado satinado / Satin finished / Finition brossé



Consultar JF BRICO / View JF Brico / Consulter JF BRICO

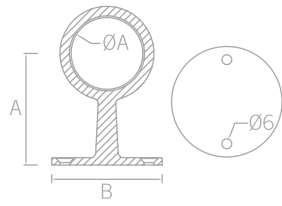

ST 304 BA AISI-316

pcs/box	ØA	A	B
2	38,1	69	57
2	43	68	67
2	50,8	78	80



BA SATIN

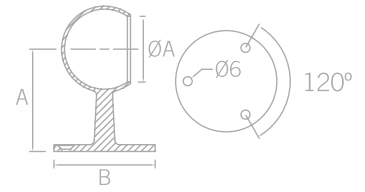

ST 305 BA AISI-316

pcs/box	ØA	A	B
2	38,1	69	57
2	43	68	67
2	50,8	78	80



BA SATIN

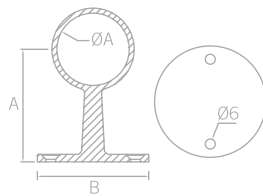

ST 306 BA AISI-316

pcs/box	ØA	A	B
2	43	72	69
2	50,8	83	63



BA SATIN

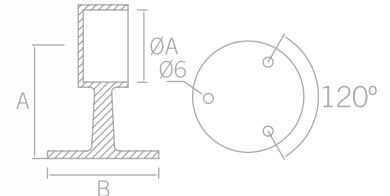

ST 307 BA AISI-316

pcs/box	ØA	A	B
2	43	72	69
2	50,8	83	63



BA SATIN

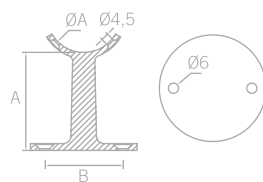

ST 311 BA AISI-316

pcs/box	ØA	A	B
2	43	57	62,5
2	50,8	57	62,5



BA SATIN

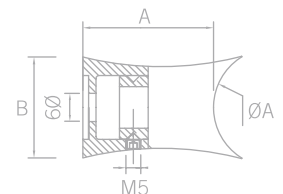

ST 313 BA AISI-316

pcs/box	ØA	A	B
2	40	44	34



BA SATIN



BA SATIN

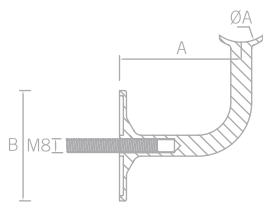

ST 340 BA AISI-316

pcs/box	ØA	A	B	D	G
2	43	70	63	16	(6/8)
2	50,8	70	63	16	(6/8)



BA SATIN

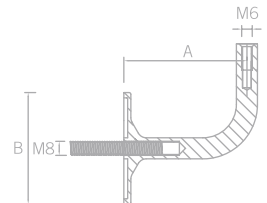

ST 350 BA AISI-316

pcs/box	A	B
2	70	63



BA SATIN

Instalación / Installation / Installation ▾

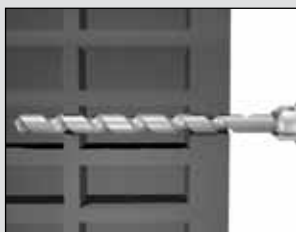

[img.1]



[img.2]

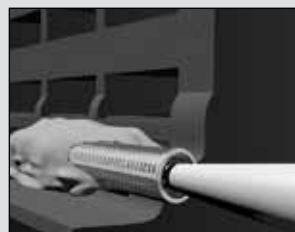

[img.3]



[img.4]

BA Acabado brillo / Polished finished / Finition poli

SATIN Acabado satinado / Satin finished / Finition brossé

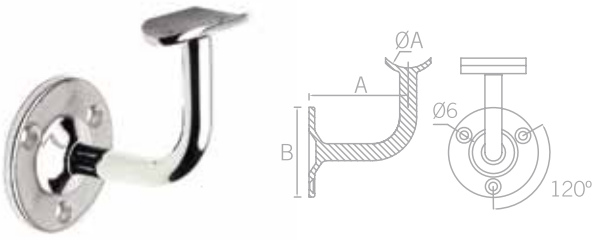

ST 303 BA AISI-316

pcs/box	øA	A	B
2	43	70	63
2	50,8	70	63



BA SATIN

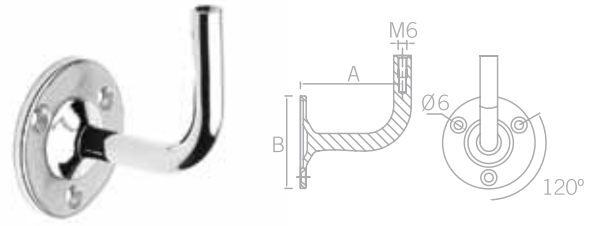

ST 351 BA AISI-316

pcs/box	A	B
2	70	63



BA SATIN

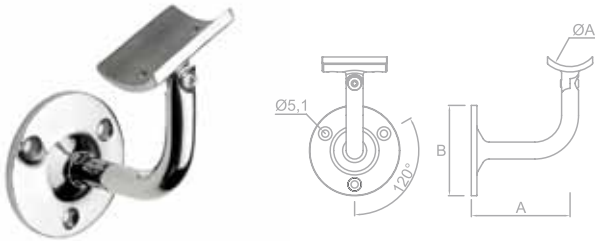

SA 410 BA AISI-316

New!

pcs/box	øA	A	B
2	38,1	70	63
2	43	70	63
2	50,8	70	63



BA SATIN

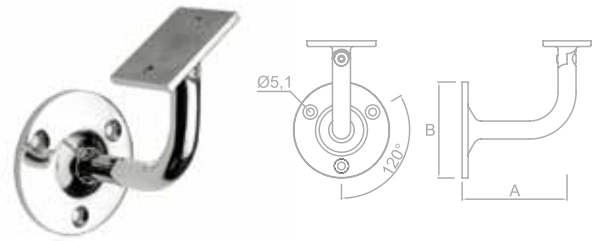

SA 411 BA AISI-316

New!

pcs/box	A	B
2	70	63



BA SATIN

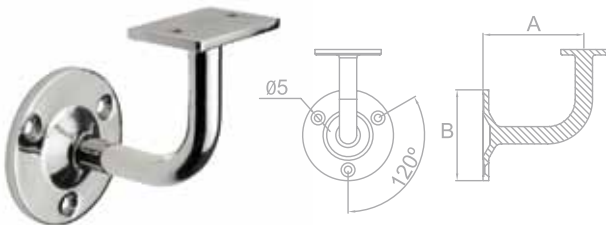

ST 316 BA AISI-316

New!

pcs/box	A	B
2	70	63



BA SATIN





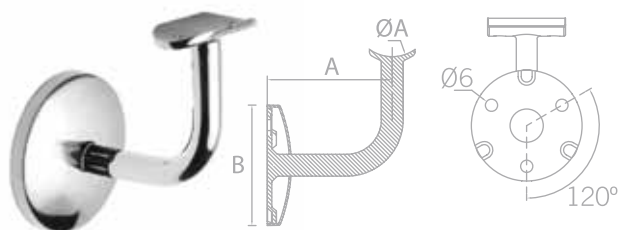

ST 353 BA AISI-316

pcs/box	ØA	A	B
2	38,1	69	66
2	43	69	66
2	50,8	69	66



BA SATIN

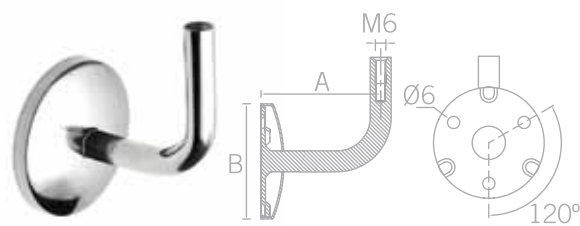

ST 352 BA AISI-316

pcs/box	A	B
2	69	66



BA SATIN



BA Acabado brillo / Polished finished / Finition poli



SATIN Acabado satinado / Satin finished / Finition brossé



Consultar JF BRICO / View JF Brico / Consulter JF BRICO

Instalación / Installation / Installation



[img.1]



[img.2]



[img.3]

Ofrecer soluciones prácticas y eficaces al profesional en la instalación es el principio de trabajo del departamento de innovación de Comenza para el desarrollo de sus accesorios.

El soporte está diseñado para posibilitar su fijación en un solo tiempo usando tacos premontados. Una vez finalizado el montaje y asegurado el soporte sobre la superficie de apoyo, se fija el embellecedor ejerciendo una pequeña presión sobre la base, quedando la goma oculta en su interior. [ img.1 ]

Pasos de instalación con ST-353:

1. Taladrado de la pared
2. Colocación de pieza
3. Fijar el soporte a la pared con el taco premontado [ img.2 ]

Pasos de instalación en soportes convencionales:

1. Taladrado de la pared
2. Colocación del tirafondo
3. Colocación de la pieza
4. Fijar el soporte [ img.3 ]

[ENG]

Offering practical and effective solutions to professional installation is the key goal of Comenza's innovation department for the development of its accessories.

This product has been designed to enable its fixing at once using nylon hammer drive anchor. Once the assembly is finished and the support is fastened on the support surface, the cover is placed pressing slightly on the base, and the rubber rests hidden inside. [ img.1 ]

Installation steps with ST-353:

1. Drill the wall.
2. Place the ST-353.
3. Fix the support to the wall with the preassembled anchor. [ img.2 ]

Installation steps with traditional supports:

1. Drill the wall.
2. Place the lag bolt.
3. Fix the piece.
4. Fix the support. [ img.3 ]

[FRA]

Offrir des solutions pratiques et efficaces au professionnel en matière d'installation, voici le point de départ du travail du Département d'innovation de Comenza pour le développement de ses accessoires.

Ce support a été conçu pour faire possible la fixation d'un coup d'ancrages pré-assemblés du type de cheville en plastique. Quand le montage est fini et le support bien fixé à la surface d'appui, on fixe l'enjoliveur en exerçant une petite pression sur la base, en restant la caoutchouc torique cache dans l'intérieur. [ img.1 ]

Installation avec le support ST-353:

1. On perce le mur.
2. On place la ST-353
3. On fixe le support au mur avec l'ancrage pré-assemblé. [ img.2 ]

Installation avec un support traditionnel:

1. On perce le mur.
2. On place la vis tire-fond.
3. On place la pièce.
4. On fixe le support. [ img.3 ]





# Jf<sup>®</sup>Deco Led



giving light to your  
handrail projects



**EL AHORRO ENERGÉTICO SE ENCUENTRA CON EL DISEÑO:  
NUEVO SISTEMA DE PASAMANOS JF DECO LED.**

**ENERGY SAVING MEETS DESIGN:  
NEW JF DECO LED HANDRAIL SYSTEM.**

**L'ÉPARGNE ÉNERGÉTIQUE SE RETROUVE AVEC LE DESIGN:  
NOUVEAU SYSTÈME DE MAIN COURANTES JF DECO LED.**

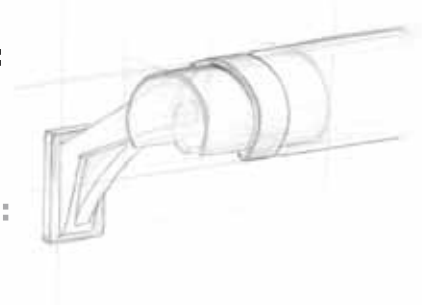

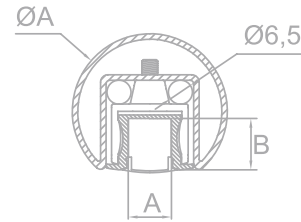

PL-20 BA AISI-304

pcs/box	ØA	A	B	L
1 kit*	42,4	12,3	14	150 mm
1 kit*	42,4	12,3	14	200 mm
1 kit*	42,4	12,3	14	250 mm
1 kit*	42,4	12,3	14	300 mm
1 kit*	42,4	12,3	14	750 mm
1 kit*	42,4	12,3	14	1000 mm

1 KIT\*: **A** Slotted tube AISI 304 + **B** AL-00 + **C** Aluminium profile and white polycarbonate lens

BA SATIN

Posibilidades de suministro de PL-20  
PL-20 Supply possibilities / Possibilités de fourniture PL-20

E	E1=150 mm E2=200 mm E3=250 mm E4=300 mm
M	M1=750 mm M2=1000 mm

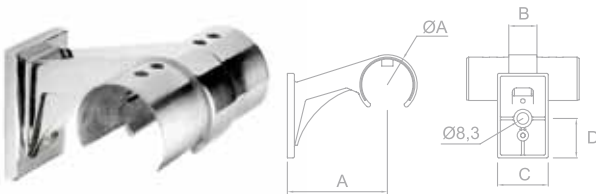
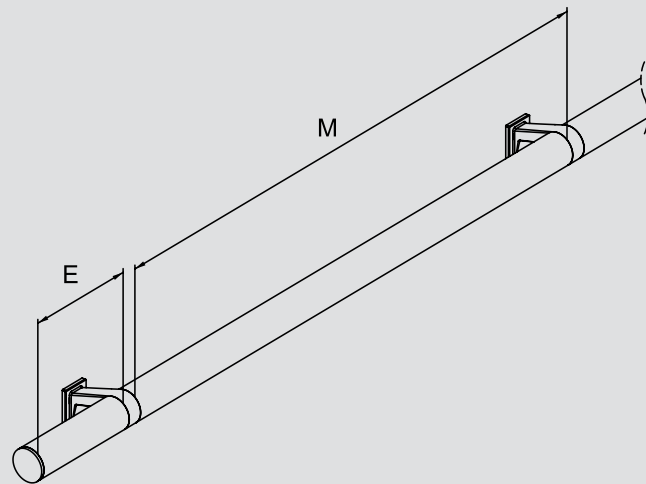

ST 345 BA AISI-316

pcs/box	ØA	A	B	C	D
2	42,4	71	20	36	28



BA SATIN



TF 512 BA AISI-316

pcs/box	ØA	A
2	42,4	4



BA SATIN



CT 211 BA AISI-316

pcs/box	ØA	A
2	42,4	50



BA SATIN

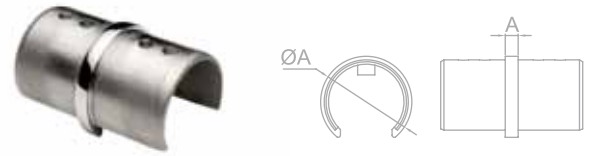

CT 212 BA AISI-316

pcs/box	ØA	A
2	42,4	6



BA SATIN

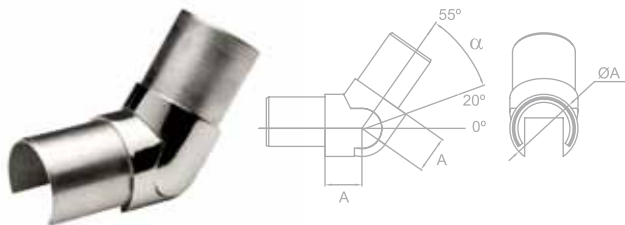

SA 416 BA AISI-316

pcs/box	ØA	A	α
2	42,4	23	20-55°



BA SATIN

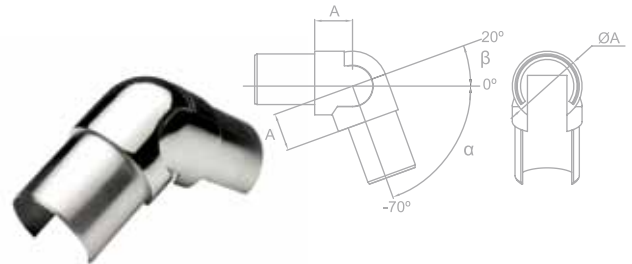

SA 417 BA AISI-316

pcs/box	ØA	A	α	β
2	42,4	23	0-70°	0-20°



BA SATIN

LEDS STRIP 12V.D.C 14.4 W  
60 LEDS SMD 5050 IP 65 3000K

m/bag	Lm/m	Colour
5m	900	Warm white



SP-200 AC/DC 12 Vdc 200W

pcs/box
1

BA

Acabado brillo / Polished finished / Finition poli

SATIN

Acabado satinado / Satin finished / Finition brossé



Consultar JF BRICO / View JF Brico / Consulter JF BRICO

Instalación / Installation / Installation ▾



[img.1]

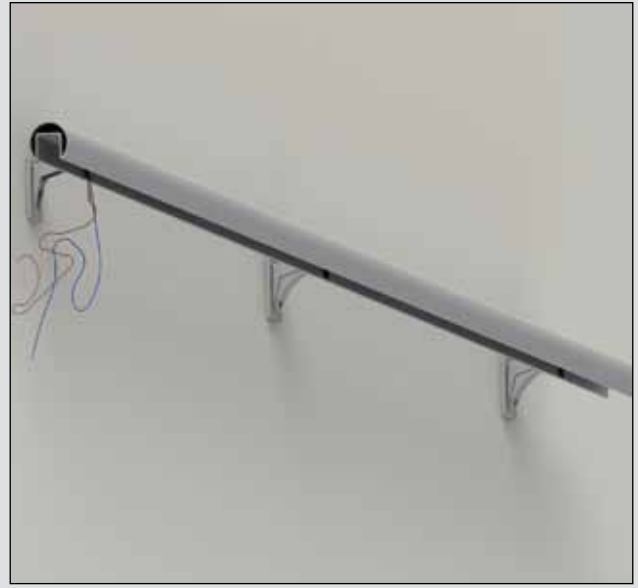

[img.2]

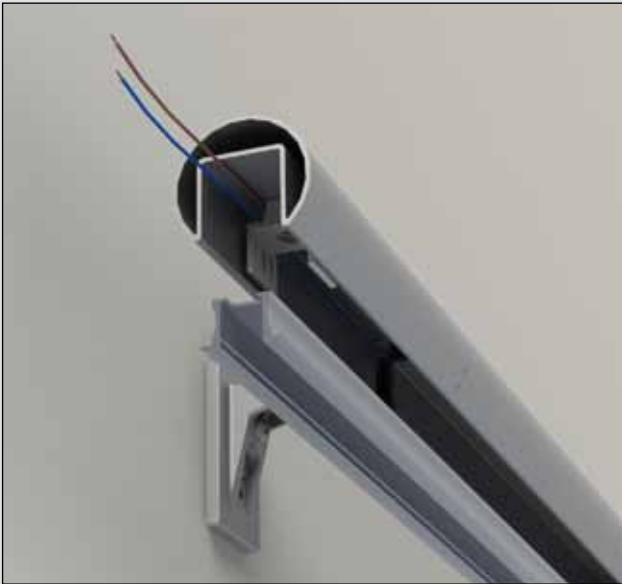

[img.3]

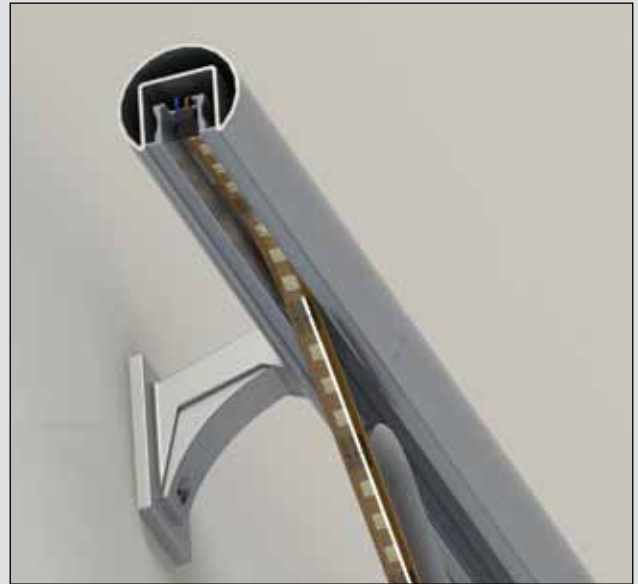

[img.4]



[img.5]

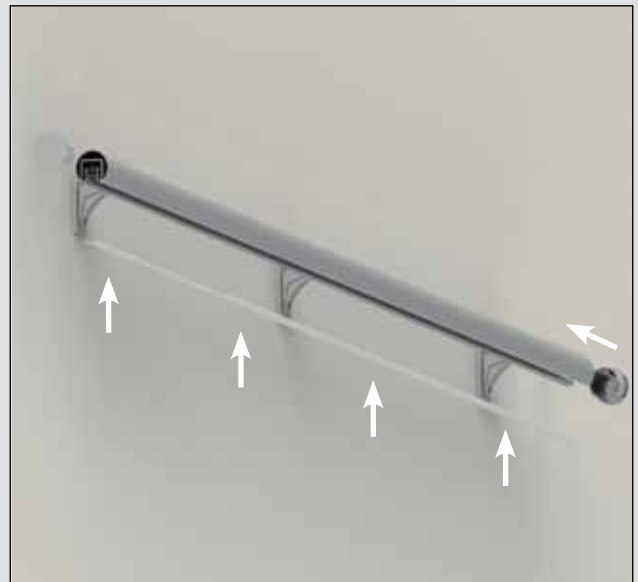

[img.6]



Posibilidades de suministro de PL-20  
 PL-20 Supply possibilities / Possibilités de fourniture PL-20

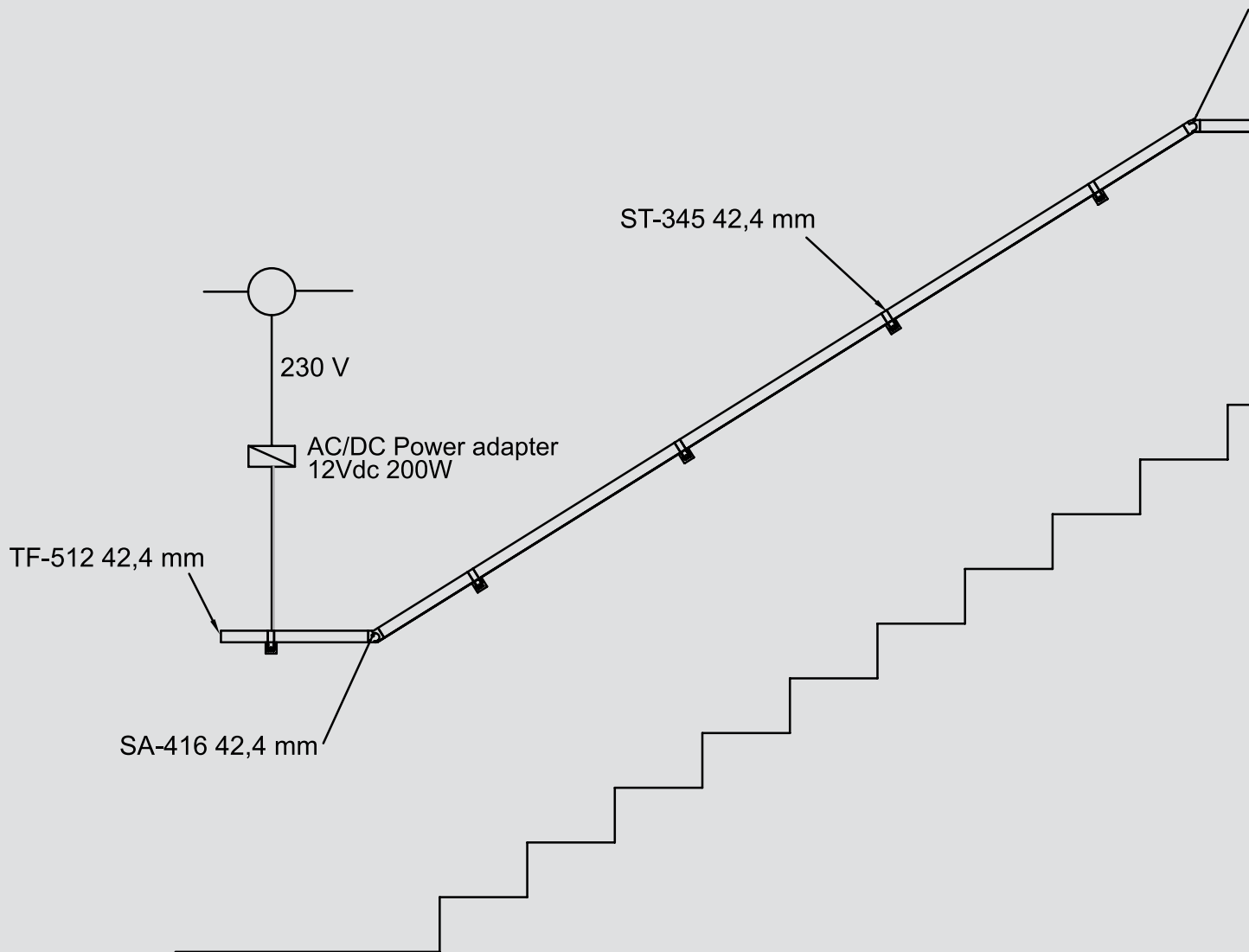

Esquema de conexionado  
 Wiring diagram / Schéma de câblage

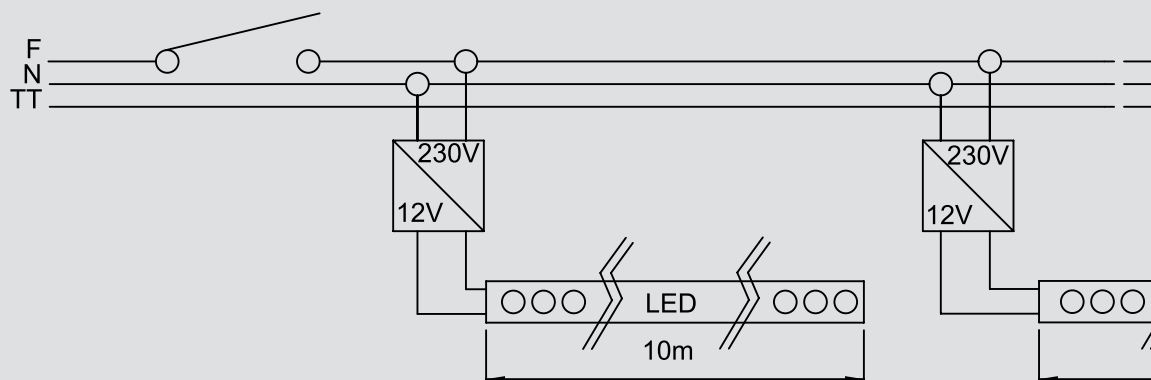

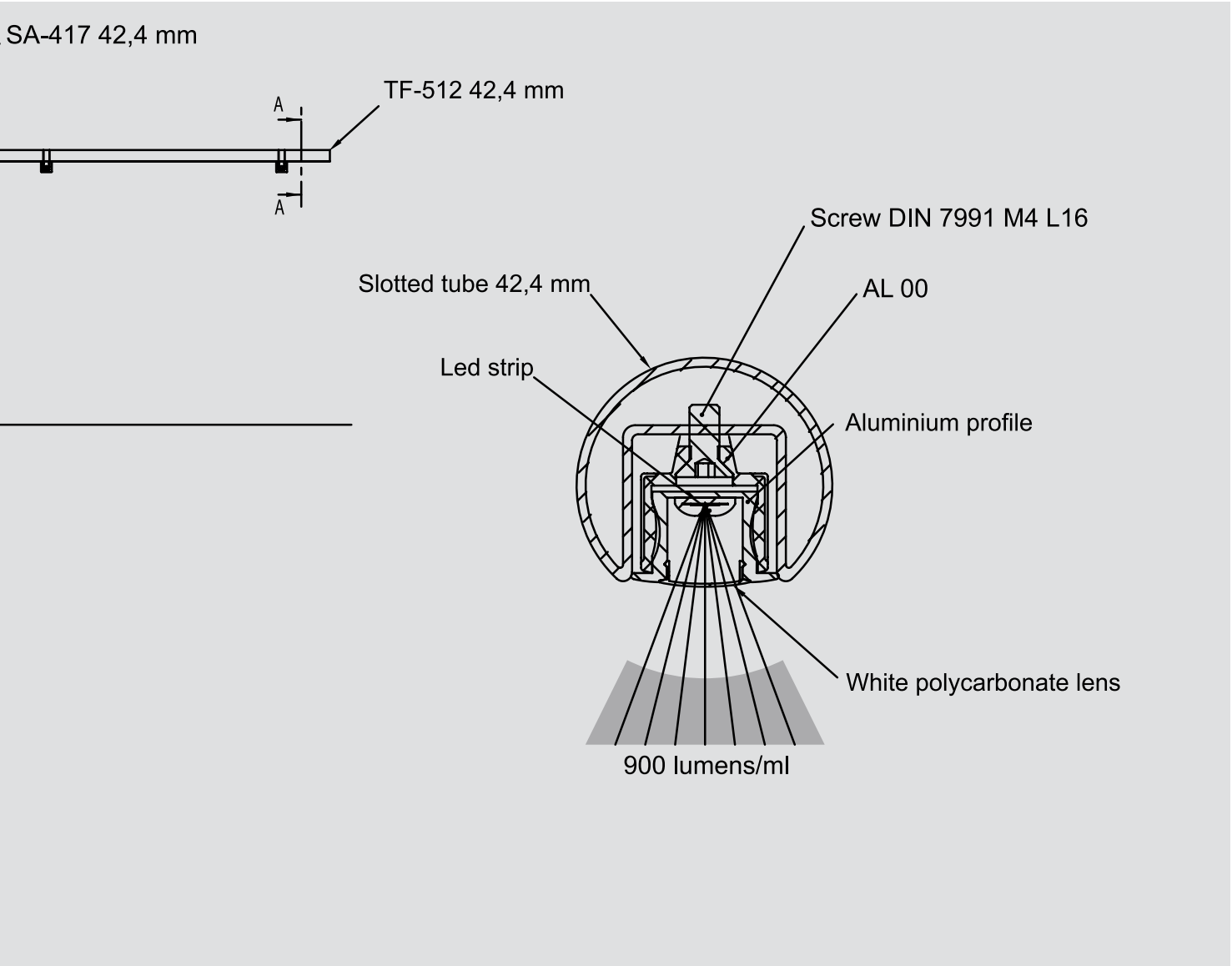

F: Fase / Phase / Phase  
 N: Neutro / Uncharged / Neutre  
 TT: Toma de tierra / Ground connection / Mise a la terre

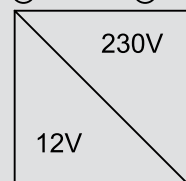

: AC/DC Power adapter 12 Vdc 200W  
 Entrada a 230V / Salida 12V

